

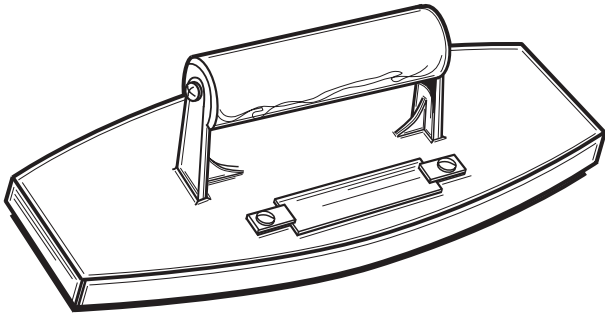

# CUSTOM CONCRETE NAME AND DATE STAMP

- The perfect way to mark concrete for permanent identification
- Made from high grade bronze
- Stamp is 9-7/8"x5" oval with flat ends
- Shipping weight is 5 lbs.



- Stamp has 16 spaces per line with 3 lines available to use and will be made exactly as you print below. Fill out the form below exactly as you would like your stamp. Each character requires one space. Leave a space between words or group of numbers as desired.
- Logos are not adaptable to this name stamp.
- The 2-1/2" long date insert (year only) is optional and placed between line 2 and line 3, clipped to the back of the stamp for easy change from year to year.
- Available characters include letters A through Z (upper case only); numbers 0 through 9; and specific symbols (comma, period, dash, slash, apostrophe, hyphen, colon, semi-colon and ampersand).
- Characters are 1/2" tall, imprinting approximately 3/16" deep. Center characters per line or start flush on left side. Lines 1 and 3 are curved as shown below, while Line 2 is straight. Overall stamp is 9-7/8"x5".

Allow approximately 2-3 weeks lead time

Return this form to your nearest Kraft Tool distributor, or fax, scan, or email directly to Kraft Tool Co.®



**Kraft Tool Co.®**

8325 Hedge Lane Terrace  
Shawnee, KS 66227, USA  
Call 913-422-4848 • Fax 913-422-1018  
Email: Salesorders@KraftTool.com  
www.KraftTool.com

\*PLEASE PRINT

## CUSTOM CONCRETE NAME AND DATE STAMP ORDER FORM

### BILLING INFORMATION

Name \_\_\_\_\_  
Business Name \_\_\_\_\_  
Address \_\_\_\_\_  
City \_\_\_\_\_ State \_\_\_\_\_ ZIP \_\_\_\_\_  
Phone \_\_\_\_\_ Email \_\_\_\_\_

### PAYMENT INFORMATION

Bill to Existing Distributor Account No. \_\_\_\_\_  
Enclosed Check No. \_\_\_\_\_  
Charge To Credit Card:  
Name on Card \_\_\_\_\_  
Card No. \_\_\_\_\_  
Expiration Date \_\_\_\_\_  
Security Code \_\_\_\_\_

### SHIPPING INFORMATION

Same as Billing Information  
Name \_\_\_\_\_  
Business Name \_\_\_\_\_  
Address \_\_\_\_\_  
City \_\_\_\_\_ State \_\_\_\_\_ ZIP \_\_\_\_\_  
Phone \_\_\_\_\_ Email \_\_\_\_\_

### ORDERING INFORMATION

Please mark correct quantities next to the part number(s) you would like to order

Quantity	No.	Description
_____	CF400	Stamp <i>with</i> Date Insert, Wood Handle
_____	CF400PF	Stamp <i>with</i> Date Insert, ProForm® Handle
_____	CF400-01	Stamp <i>without</i> Date Insert, Wood Handle
_____	CF400PF-01	Stamp <i>without</i> Date Insert, ProForm® Handle
_____	CF401-24	2024 Date Insert Only (2-1/2"x7/8")
_____	CF401-25	2025 Date Insert Only (2-1/2"x7/8")